

内置BOOST升压的2×5.5W立体声音频功率放大器

■ 特点

- 防削顶失真功能(Anti-Clipping Function, ACF)
- 免滤波器数字调制, 直接驱动扬声器
- 输出功率

$2 \times 5.5W (V_{BAT} = 4V, PVDD = 7V, R_L = 4\Omega,$

THD+N=10%)

- 电源
 - 升压输入 V_{BAT} : 2.5V至5.5V
 - 升压输出 $PVDD$: V_{BAT} 至7.0V
- BOOST输出电压可调
- AB/D类切换
- 过流/过热/欠压异常保护功能
- 无铅封装, SOP16L-PP

芯片料号	内置输入电阻 R_{IN}	工作模式
HT8699RSPEX	17.8K ohm	D类和AB类
HT8699B6SPEX	10 ohm	D类

■ 典型应用图

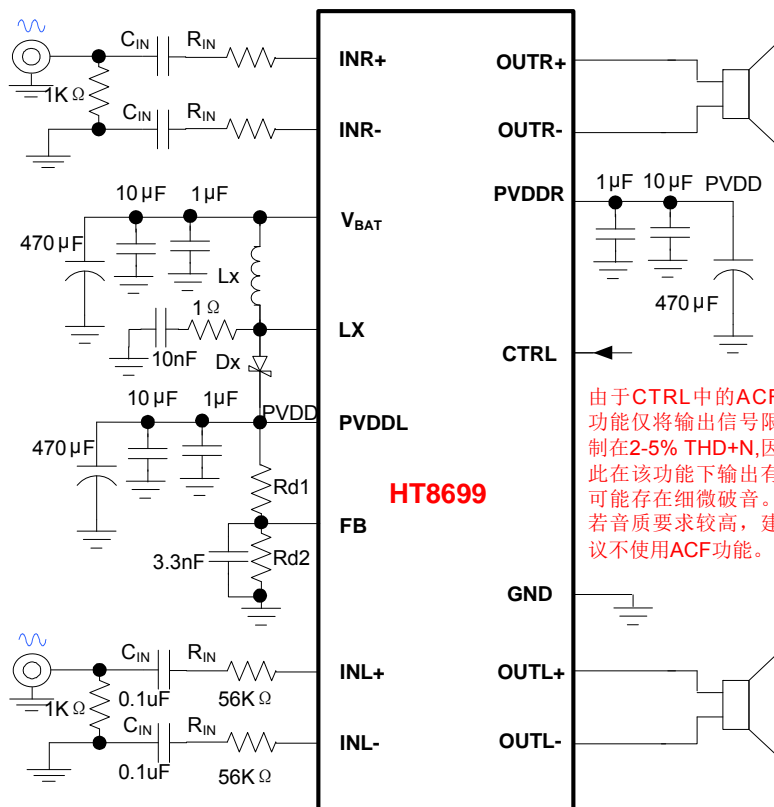

■ 概述

HT8699是一款内置BOOST升压模块的立体声音频功率放大器。在D类模式下,内置的BOOST升压模块可通过外置电阻调节升压值,即使是锂电池供电,在升压至7V时,10% THD+N,4Ω负载条件下,能连续输出2×5.5W 的功率。

HT8699具有AB类和D类的自由切换功能,在受到D类功放EMI干扰困扰时,可随时切换至AB类音频功放模式。

HT8699内部集成免滤波器数字调制技术,能够直接驱动扬声器,并最大程度减小脉冲输出信号的失真和噪音。输出无需滤波网络,极少的外部元器件节省了系统空间和成本,是便携式应用的理想选择。

此外,HT8699内置的关断功能使待机电流最小化,还集成了输出端过流保护、片内过温保护和电源欠压异常保护等功能。

■ 应用

- 蓝牙音箱
- 2.1声道小音箱
- iphone/ipod/ipod docking
- 便携式音箱
- 扩音器
- 便携式游戏机

2 × 5.5W Stereo Audio Amplifier with Boost Converter

■ FEATURE

- Anti-Clipping Function (ACF)
- Filter-less Modulation, Eliminating Output Filter
- Output Power
 $2 \times 5.5W (V_{BAT}=4V, PVDD = 7V, R_L=4\Omega, THD+N=10\%)$
- -BOOST Input V_{BAT} : 2.5V to 5.5V
 -BOOST Output PVDD: V_{BAT} to 7.5V
- Adjustable BOOST Output Voltage
- Class AB /Class D available
- Thermal Protection, Over current protection, Low voltage malfunction prevention function included
- Pb-Free Packages, SOP16L-PP

Part No.	Internal Resistor R_{IN}	Working Mode
HT8699RSPEX	17.8K ohm	Class D & Class AB
HT8699B6SPEX	10 ohm	Class D

■ APPLICATIONS

- Bluetooth Speakers
- Portable Speakers
- iPhone/iPod/iPod docking
- Megaphone

■ 典型应用图

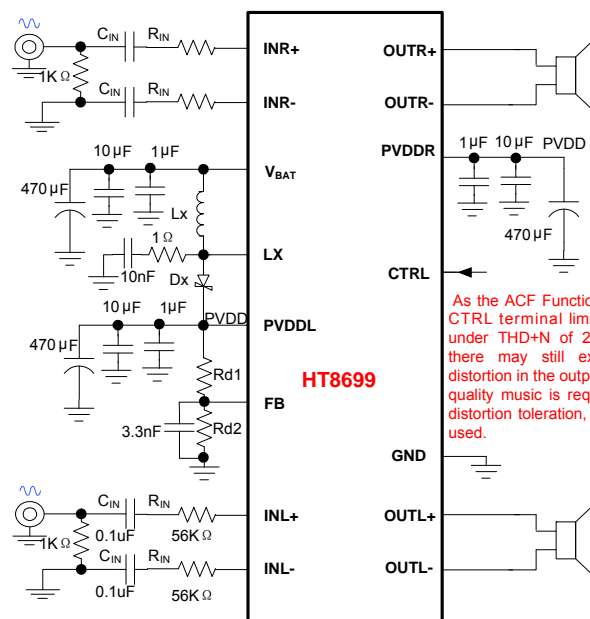

■ GENERAL DESCRIPTION

HT8699 integrates a boost converter with a filter-less stereo class D audio power amplifier to provide $2 \times 5.5W$ continuous power into a 4Ω speaker when operating from a Li-battery voltage boosted to 7V. Meanwhile, the boost output voltage is adjustable.

Class AB amplifier mode is also available for HT8699. Once the EMI Interference from class D and Boost Converter becomes an annoying problem, HT8699 can be switched into Class AB mode.

HT8699 has a filter-less modulation circuit which directly drives speakers while realizes low distortion and low noise characteristics. Thanks to filter-less, circuit design with fewer external parts can be made in portable applications.

HT8699 has the independent Shutdown function which can minimize the power consumption at standby and MUTE function. As for protection function, over current protection, over temperature protection function, and low supply voltage malfunction preventing function are also prepared.

■ TERMINAL CONFIGURATION

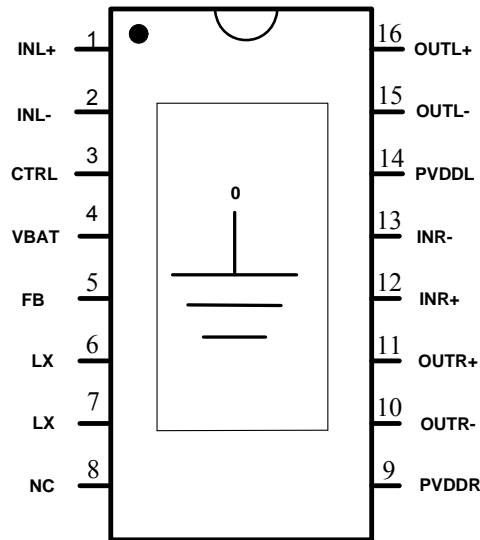

SOP16L-PP Top View

■ TERMINAL FUNCTION¹

Terminal No.	Name	I/O	ESD Protection	Function
0	GND	GND	-	Power Ground. Do connect to the system Ground.
1	INL+	I	PN	Left channel positive input (differential +)
2	INL-	I	PN	Left channel negative input (differential -)
3	CTRL	I	PN	Shutdown and ACF control terminal
4	VBAT	Power	PN	Logic Power Supply
5	FB	I	PN	Regulator Feedback Input
6,7	LX	I	-	Internal Switch Input
8	NC			No connection. Connect to GND for better thermal performance
9	PVDDR	Power	-	Boost Converter Output Voltage, Power Supply for Class D Right Channel
10	OUTR-	O	-	Right channel negative output (BTL-)
11	OUTR+	O		Right channel positive output (BTL+)
12	INR+	I	PN	Right channel positive input (differential +)
13	INR-	I	PN	Right channel negative input (differential -)
14	PVDDL	Power	-	Boost Converter Output Voltage, Power Supply for Class D Left Channel
15	OUTL-	O	-	Left channel negative output (BTL-)
16	OUTL+	O		Left channel positive output (BTL+)

¹ I: Input O: Output

ORDERING INFORMATION

Part Number	Available Working Mode	Internal Input Resistor R_{IN}^1	Package Type	Marking	Operating Temperature Range	MOQ/Shipping Package
HT8699RSPER	Class AB & Class D	17.8k ohm	SOP16L-PP	HT8699R _{SP}	-40°C~85°C	Tube / 50 PCS
HT8699RSPET	Class AB & Class D	17.8k ohm	SOP16L-PP	HT8699R _{SP}	-40°C~85°C	Tape and Reel 2500PCS
HT8699B6SPET	Class D	10ohm	SOP16L-PP	HT8699 _{SP}	-40°C~85°C	Tube / 50 PCS
HT8699B6SPER	Class D	10ohm	SOP16L-PP	HT8699 _{SP}	-40°C~85°C	Tape and Reel 2500PCS

ELECTRICAL CHARACTERISTIC

Absolute Maximum Ratings ²

Item	Symbol	Min.	Max.	Unit
Power supply voltage range	V_{BAT}	-0.3	5.5	V
BOOST converter output voltage range	PVDD	V_{BAT}	7.0	V
Input terminal voltage range (IN+, IN-)	V_{IN}	$V_{SS}-0.6$	$PVDD+0.6$	V
Input terminal voltage range (except IN+, IN-)	V_{IN}	$V_{SS}-0.3$	$PVDD+0.3$	V
Operating Ambient Temperature	T_A	-40	85	°C
Junction Temperature	T_J	-40	150	°C
Storage Temperature	T_{STG}	-50	150	°C

Recommended Operating Condition

Item	Symbol	Conditions	Min.	Typ.	Max.	Unit
Power Supply Voltage ³	V_{BAT}		2.5	3.6	5.5	V
BOOST converter output voltage range	PVDD		V_{BAT}	6.0	7.0	V
Operating Ambient Temperature	T_a		-40	25	85	°C
Speaker Impedance	R_L		4			Ω

¹ See Fig. 3 in Page 12 for detail.

² Absolute Maximum Ratings is values which must not be exceeded to guarantee device reliability. With a system in which supply voltage might exceed supply voltage of PVDD/GND, external diodes are recommended to be used to assure that the voltage does not exceed the absolute maximum rating.

³ The rising time of V_{BAT} should be more than 1 μ s.

● **Electrical Specification¹**

Item	Symbol	Conditions	Min.	Typ.	Max.	Unit	
BOOST Converter							
Boost converter output voltage	PVDD		V _{BAT}	6.0	7.0	V	
Boost converter frequency	f _{SW}			420		kHz	
Boost converter input current limit	I _{LIMITRIP}			4.6		A	
Class D Channel V _{SS} =0V, V _{BAT} =3.6V, PVDD = 6.0V, R _{IN} = 56K, T _a =25°C, C _{IN} =1uF, ACF-Off mode, unless otherwise specified							
Carrier clock frequency	f _{PWM}			420		kHz	
Over current protection	I _{max}				5	A	
System Gain	A _{v0}	External R _{IN} =56 kΩ, for HT8699B6SPEX		26		dB	
		External R _{IN} =0, for HT8699RSPEX		27.5			
Start-up time (power-on or shutdown release)	t _{STUP}			260		ms	
ACF attenuation gain	A _a		-16		0	dB	
Consumption current in shutdown mode	I _{SD}	CTRL=V _{SS}		23		μA	
Output Power	P _O	R _L =4Ω	V _{BAT} =3.6V, f=1kHz, THD+N=10%	2×4.5		W	
		R _L =8Ω		2×2.6			
		R _L =4Ω		V _{BAT} =3.6V, f=1kHz, THD+N=1%	2×3.7		
		R _L =8Ω			2×2.1		
Total Harmonic Distortion plus Noise	THD+N	PVDD = 6V	P _O =1.0W R _L =4Ω, f=1kHz	0.12		%	
		PVDD = 6.5V		0.11		%	
		PVDD = 7V		0.11		%	
Output Noise	V _N	f=20Hz~20kHz, A weighted, A _v =26dB		155		μV _{rms}	
Signal to Noise Ratio	SNR	A weighted, A _v =26dB, THD+N = 1%		88		dB	
Output offset voltage	V _{OS}			±2		mV	
Crosstalk	CS	L -> R	f = 1kHz, P _O = 1W	-100		dB	
		R -> L		-85			
Efficiency (Class D + Boost)	η	V _{BAT} =3.6V, R _L =4Ω+22uH, THD+N = 1%		70		%	
		V _{BAT} =3.6V, R _L =8Ω+33uH, THD+N = 1%		77		%	
Quiescent current	I _{BAT}	No Load	Input Grounded	27		mA	
		With Load ²		26		mA	
Maximum Input Signal	V _{INmax}	f _{IN} = 1kHz, THD+N ≤ 10%, ACF-1 ON		1.5		V _{rms}	

¹ Depending on parts and pattern layout, characteristics may be changed.

² 4ohm resistor and 22uH coil are used as an output load in order to simulate a speaker.

Item	Symbol	Conditions	Min.	Typ.	Max.	Unit	
Class AB Channel $V_{SS}=0V$, $V_{BAT}=3.6V$, $A_v=20dB$, $T_a=25^{\circ}C$, $C_{IN}=1\mu F$, HT8699RSPEX , unless otherwise specified							
Output Power	P_o	$f=1kHz$, THD+N=10%	$R_L=4\Omega$, $V_{BAT}=3.6V$		1.3		W
			$R_L=4\Omega$, $V_{BAT}=4.2V$		1.8		W
			$R_L=4\Omega$, $V_{BAT}=5.0V$		2.65		W
		$f=1kHz$, THD+N=1%	$R_L=4\Omega$, $V_{BAT}=3.6V$		1.0		W
			$R_L=4\Omega$, $V_{BAT}=4.2V$		1.5		W
			$R_L=4\Omega$, $V_{BAT}=5.0V$		2.1		W
Total Harmonic Distortion plus Noise	THD+N	$P_o=0.01W$	$R_L=4\Omega$, $f=1kHz$		0.12		%
		$P_o=0.1W$			0.1		%
Output Noise	V_N	$f=20Hz\sim 20kHz$, A weighted $A_v=20dB$			75		μV_{rms}
Signal to Noise Ratio	SNR	A weighted, $A_v=20dB$, THD+N = 1%			90		dB
Output offset voltage	V_{OS}				± 4		mV
Efficiency	η	$R_L=4\Omega+22\mu H$, THD+N = 10%			70		%
		$R_L=8\Omega+33\mu H$, THD+N = 10%			74.5		%
Quiescent current	I_{BAT}	Input Grounded	No Load		20		mA
			With Load		20		mA
Current consumption in Mute mode	I_{MUTE}	Input Grounded, MUTE = H	No Load		2.0		mA
			With Load		2.0		mA
Current consumption in Shutdown mode	I_{SD}	CTRL= V_{SS}			36		μA
System Gain	A_{V0}	External $R_{IN}=0$			21.5		dB
Start-up time (power-on, shutdown release, or shift between Class D and Class AB)	t_{STUP}				260		ms
MISCELLANEOUS							
V_{BAT} start-up threshold voltage	V_{UVLH}				2.5		V
V_{BAT} shut-down threshold voltage	V_{UVLL}				2.2		V

Item	Symbol	Conditions	Min.	Typ.	Max.	Unit
SD wake up voltage	V _{CTRL_ON}		0.9			V
CTRL Terminal Voltage for HT8699B6SPEX						
Class D mode in ACF-Off with Boost Converter	V _{MOD1}		0.75× PVDD		PVDD	V
Class D mode in ACF-1 with Boost Converter	V _{MOD2}		0.45× PVDD		0.70× PVDD	V
Class D mode in ACF-2 with Boost Converter	V _{MOD3}		0.10× PVDD		0.40× PVDD	V
SD mode	V _{MOD4}	Shutdown mode	V _{SS}		0.06× (V _{BAT} -V _F ¹)	V
Internal pull-down Resistor of CTRL	R _{CTRL}			60		K Ω
CTRL Terminal Voltage for HT8699RSPEX						
Class D mode in ACF-Off with Boost Converter	V _{MOD1}		2.4		V _{BAT}	V
Class D mode in ACF-1 with Boost Converter	V _{MOD2}		1.6		2.2	V
Class AB mode in ACF-off without Boost Converter	V _{MOD3}		0.4		1.4	V
SD mode	V _{MOD4}	Shutdown mode	V _{SS}		0.2	V
Internal pull-down Resistor of CTRL	R _{CTRL}			150		K Ω

¹ V_F is the forward voltage of external diode.

TYPICAL OPERATING CHARACTERISTICS

 Condition: Class D mode, $V_{BAT} = 3.6V$, $f_{IN} = 1kHz$, $C_{IN} = 1\mu F$, ACF off, Load = $40\Omega + 33\mu H$, unless otherwise specified

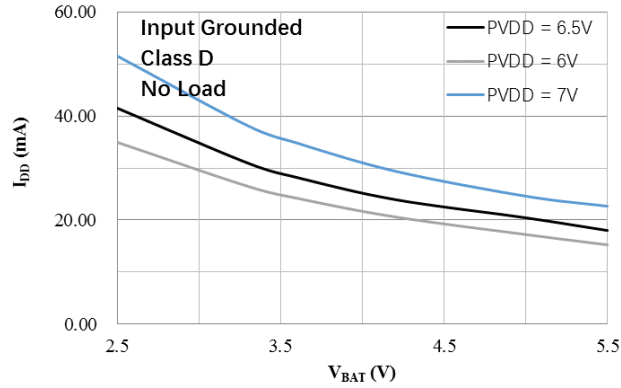
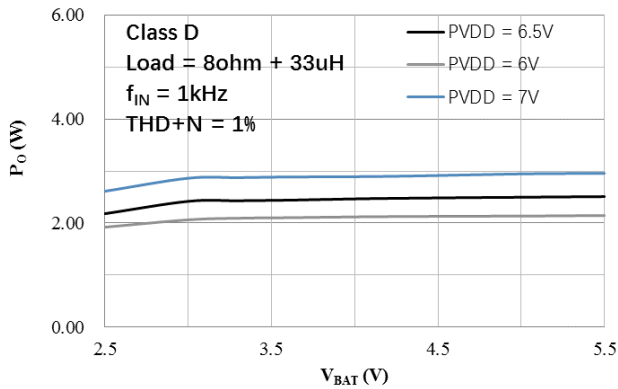
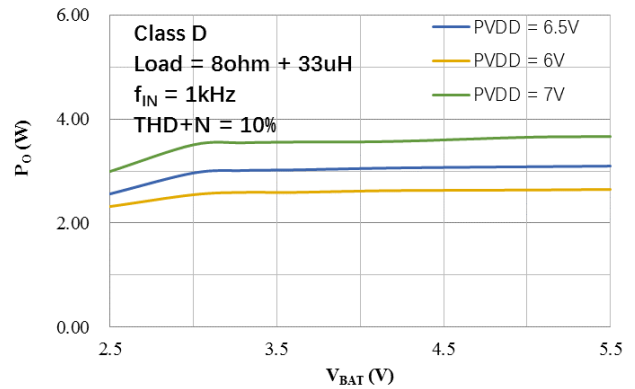
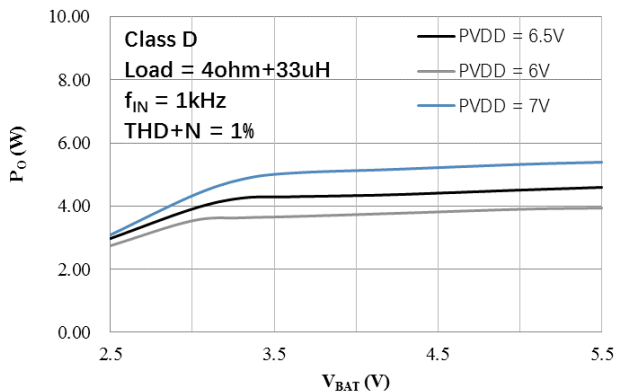
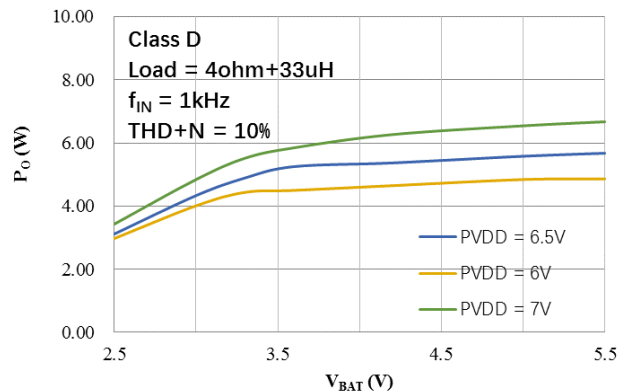
 V_{BAT} vs I_{DD}

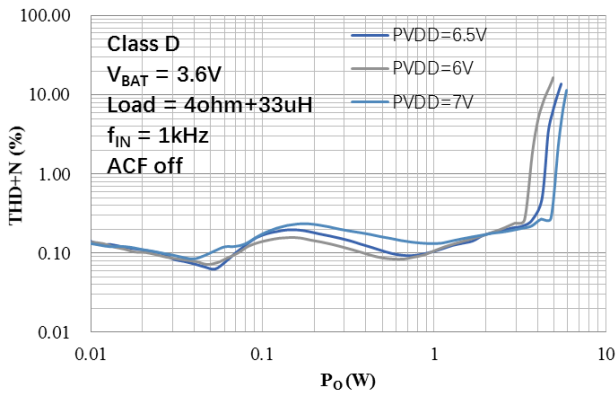
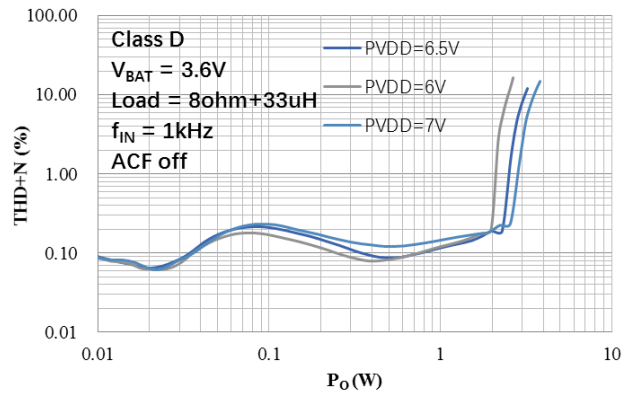
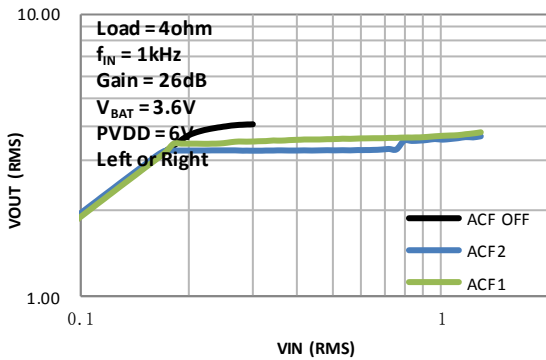
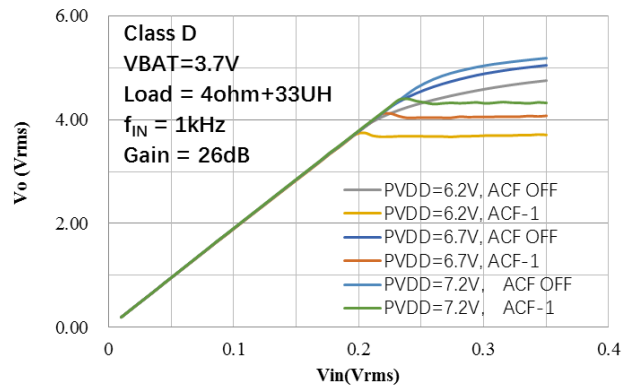
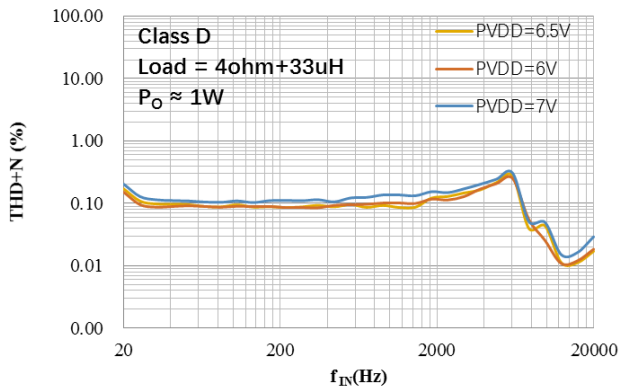
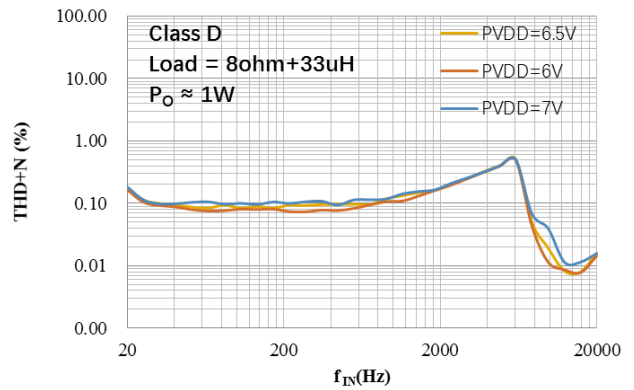
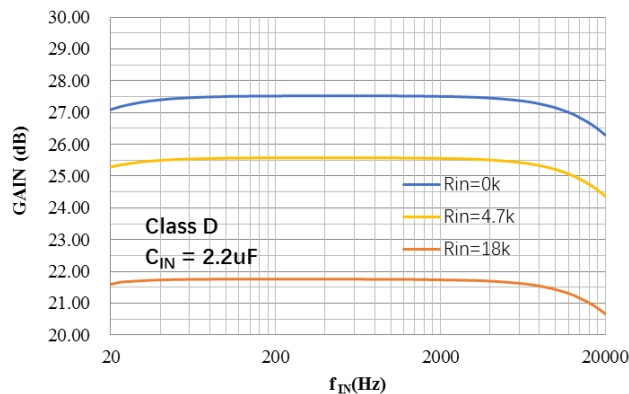
 V_{BAT} vs P_O

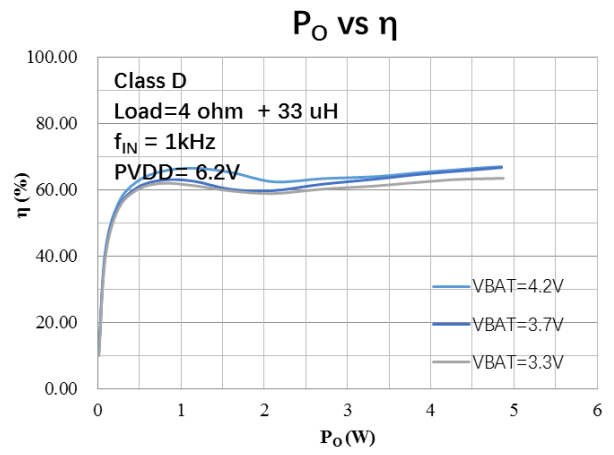
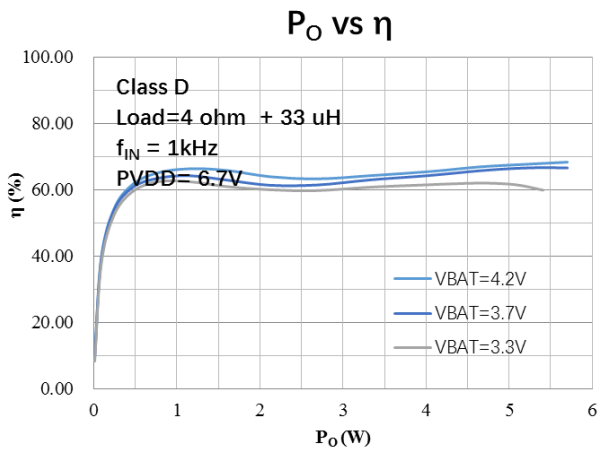
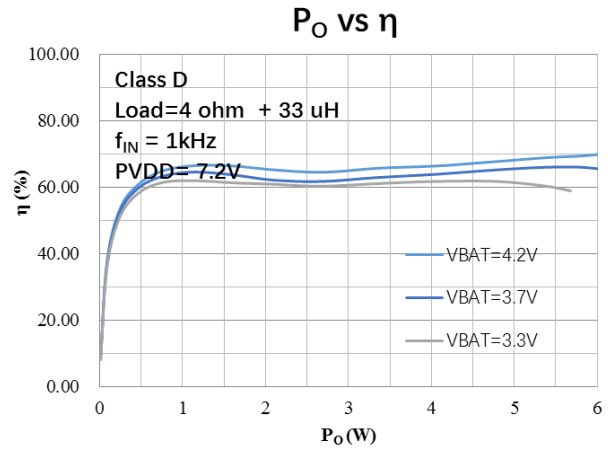
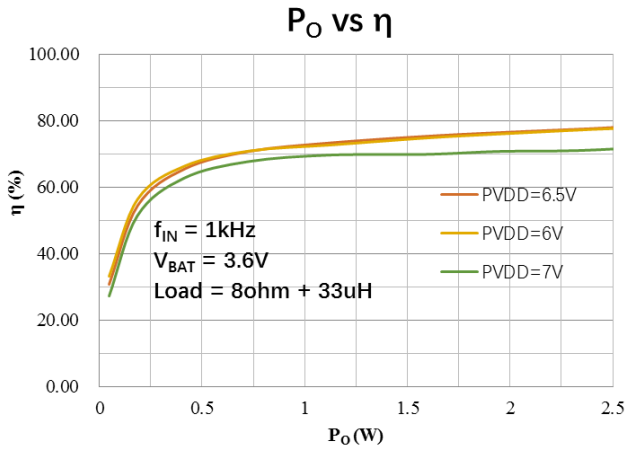
 V_{BAT} vs P_O

 V_{BAT} vs P_O

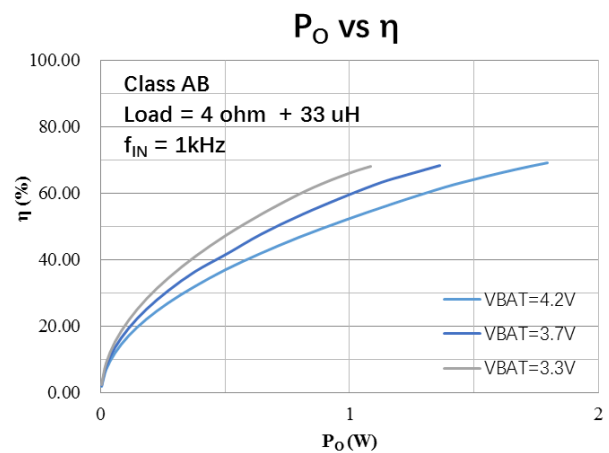
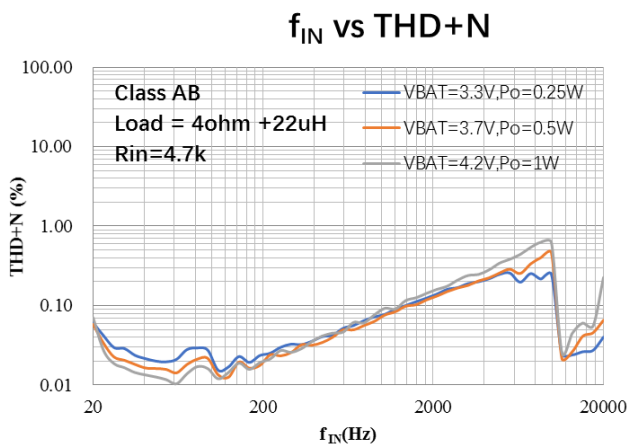
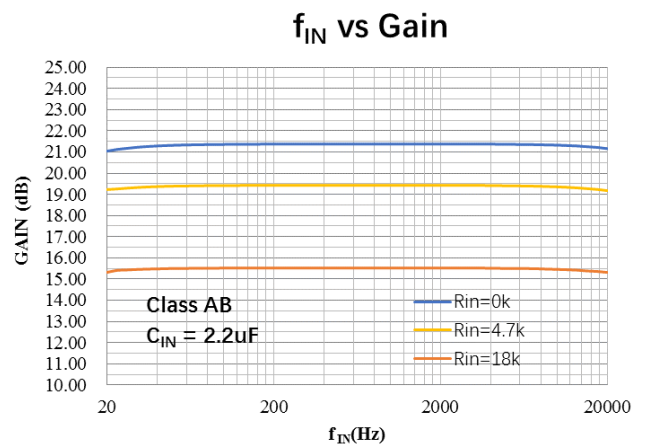
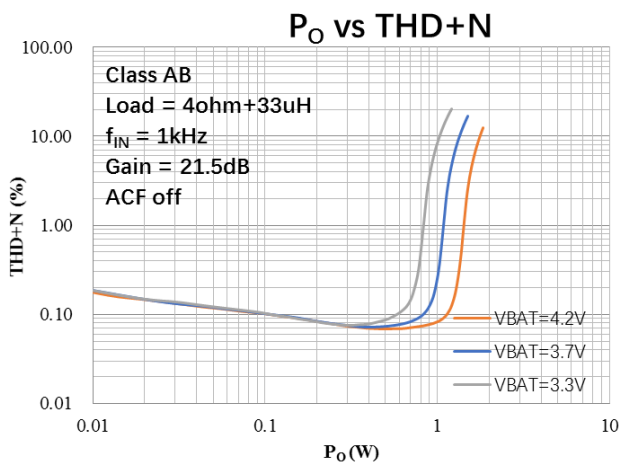
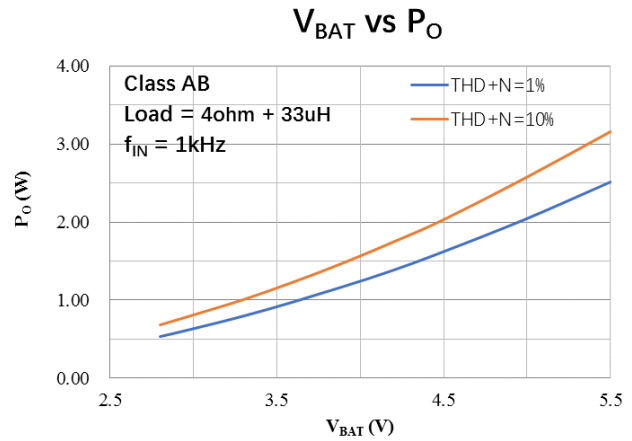
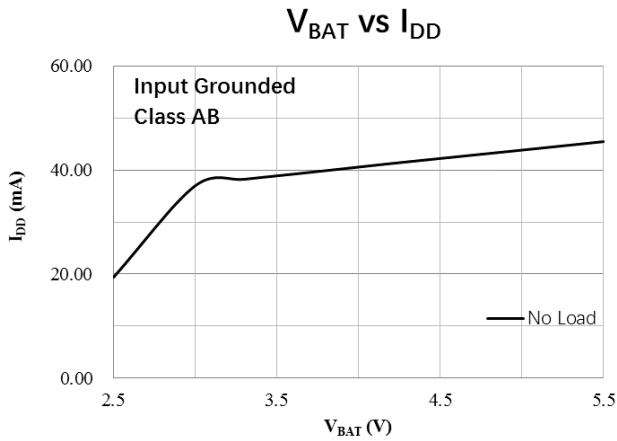
 V_{BAT} vs P_O

P_O vs THD+N

 P_O vs THD+N

 V_{IN} vs V_{OUT}

 V_{in} vs V_o

 f_{IN} vs THD+N

 f_{IN} vs THD+N

 f_{IN} vs Gain



Class AB Channel

 Condition: Class AB mode (HT8698RSPEX), $V_{BAT} = 3.6V$, $f_{IN} = 1kHz$, Load = 4ohm, unless otherwise specified

APPLICATION INFORMATION

● BOOST Converter

(1) Setting Output Voltage

The output voltage is set by a resistive voltage divider from the output voltage to FB terminal, which is shown below. The output voltage can be calculated by $PVDD = 1.24 \cdot (Rd1 + Rd2) / Rd2$.

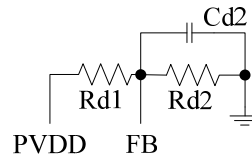

Fig. 1 FB Terminal Configuration

Some typical output voltages can be got by following settings.

Table 1. Output Voltage Setting

PVDD	Rd1	Rd2	Cd2
5.0V	120K	39.5K	3.3nF
6.0V	120k	31k	3.3nF
6.5V	120K	28K	3.3nF
7.0V	120K	25.5K	3.3nF

(2) LX Terminal

It is strongly recommended to place an RC circuit from the terminal of LX to Ground, shown as following, so that the ripple current of Boost Converter can be decreased. Meanwhile, the total consumption current of the system will be larger so that the efficiency of the system will be lower. Specifications in this file is measured under the condition with RC.

Notes: RC should be placed as closely to LX pin as possible.

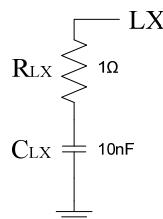

Fig. 2 LX Terminal Configuration

(3) Capacitor Selection

The input and output capacitor (C_{IN} and C_{OUT}) is required to maintain the DC voltage. Low ESR capacitors are preferred to reduce the output voltage ripple. 1uF//10uF//220uF (paralleled) is highly recommended to be placed in both input and output terminal as closely to the pin as possible. If possible, 470uF is better than 220uF.

(4) Inductor Selection

Inductance value is decided based on different condition. $L \geq 10\mu H$, $DCR < 1\text{ohm}$, $I_{SAT} \geq 5A$ is recommended for general application circuit.

(5) Schottky Diode Selection

$V_{RRM} > 12V$, $V_{FM} < 0.5V$, $I_F \geq 4A$ is recommended for general application circuit.

(6) Layout Consideration

1. The power traces, consisting of the GND, LX, V_{BAT} and PVDD trace should be kept short, direct, wide,

and as closely to the pin as possible. The switching node LX should be paid more attention for EMI and reliability consideration.

- Place C_{IN} and C_{OUT} near V_{BAT} and $PVDD$ as closely as possible to maintain voltage steady and filter out the pulsing current.
- The resistive divider R should be connected to pin directly as closely as possible. FB is a sensitive node. Please keep it away from switching node, LX .
- The GND of the IC, C_{IN} and C_{OUT} should be connected close together directly to ground plane.

● Analog Signal Input Configuration

HT8699 is an amplifier with analog input (single-ended or differential). For a differential operation, input signals into $IN+$ and $IN-$ pins via DC-cut capacitors (C_{IN}) and external input resistors R_{IN} . The input signal gain is calculated by $Gain \approx R_F / (External R_{IN} + Internal R_{IN})$. And the high pass cut-off frequency of input signal can be

$$calculated\ by\ f_c = \frac{1}{2\pi(External\ R_{IN} + External\ R_{IN}) \times C_{IN}}$$

For a single-ended operation, input signals to $IN+$ pin via a DC-cut capacitor (C_{IN}) and external input resistor (R_{IN}). $IN-$ pin should be connected to ground via a DC-cut capacitor and external input resistor (R_{IN}) (with the same value of C_{IN} and R_{IN}). The Gain and high pass Cut-off frequency are the same as the above case.

Part No.	Working Mode	Internal R_{IN} (ohm)	R_F (ohm)
HT8699B6SPEX	Class D mode	10	1200K
HT8699RSPEX	Class D mode	17.8k	420K
HT8699RSPEX	Class AB mode	17.8k	210K

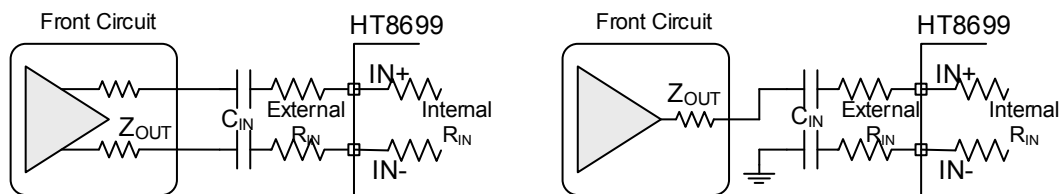

Fig. 3 (1) Differential Input;

(2) Single-ended Input

● Output Configuration

As mentioned, HT8699 can directly drive speakers without any other components. But there are exceptions. Once HT8699 works in class D mode, the cable lined to the speaker is very long, and EMI is concerned, ferrite beads or L-C filter is needed.

● CTRL Terminal Mode Control

HT8699 can work in different modes by setting the CTRL terminal, shown as follow.

Table. 2 CTRL Terminal Mode Control for **HT8699RSPEX**

MODE	SYMBOL	CTRL Voltage			
		MIN.	TYP.	MAX.	UNIT
Class D mode in ACF-Off with Boost Converter	V_{MOD1}	2.4		V_{BAT}	V
Class D mode in ACF-1 with Boost Converter	V_{MOD2}	1.6		2.2	V
Class AB mode in ACF-off without Boost Converter	V_{MOD3}	0.4		1.4	V
SD(Shutdown) Mode	V_{MOD4}	VSS		0.2	V

Notes: ACF-1 and ACF-2 mode can only be worked in class D mode. A 150k Ω pull-down resistor (R_{CTRL}) are inside of the CTRL terminal, shown as follows.

Table. 3 CTRL Terminal Mode Control for HT8699B6SPEX

MODE	SYMBOL	CTRL Voltage			
		MIN.	TYP.	MAX.	UNIT
Class D mode in ACF-Off with Boost Converter	V _{MOD1}	0.75× PVDD		PVDD	V
Class D mode in ACF-1 with Boost Converter	V _{MOD2}	0.45× PVDD	0.66× PVDD	0.70× PVDD	V
Class D mode in ACF-2 with Boost Converter	V _{MOD3}	0.10× PVDD	0.33× PVDD	0.40× PVDD	V
SD(Shutdown) Mode	V _{MOD4}	GND		0.06× (V _{BAT} -V _F ¹)	V

Notes: ACF-1 and ACF-2 mode can only be worked in class D mode. A 60kΩ pull-down resistor (R_{CTRL}) are inside of the CTRL terminal, shown as follows.

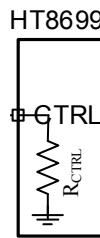

Fig. 4 CTRL Terminal

● **Anti-Clipping Function (ACF) and mode Configuration**

(1) ACF ON Mode

In ACF-ON modes, HT8699 attenuates system gain to an appropriate value when an excessive input is applied, so as not to cause the clipping at the differential signal output. In this way, the output audio signal is controlled in order to obtain a maximum output level without distortion. And HT8699 also follows to the clips of the output waveform due to the decrease in the power-supply voltage.

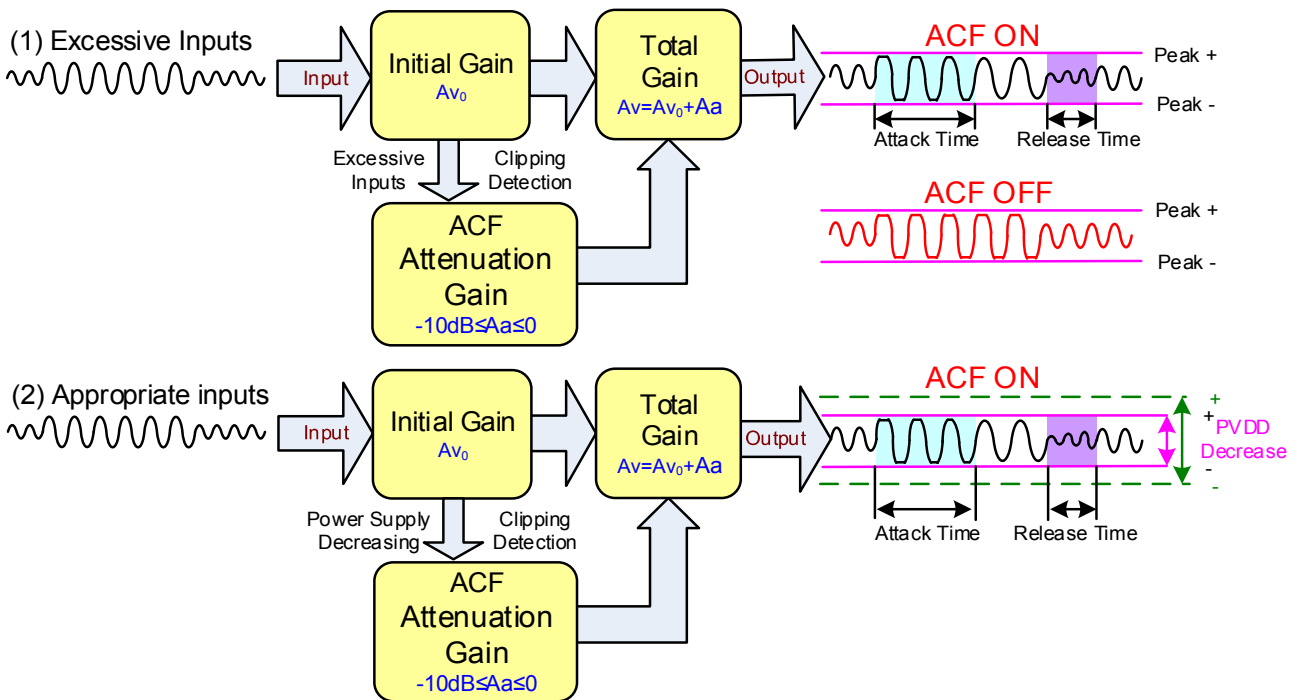

Fig. 5 the ACF Function Operation Outline

¹ V_F is the forward voltage of external diode.

The Attack time of ACF Function is a time interval until system gain falls to target attenuation gain -3dB when a big enough signal input. And, the Release Time is a time from target attenuation gain to not working of ACF. The maximum attenuation gain is 16dB.

Table 4 Attack time and Release time

ACF mode	Attack time	Release time
ACF-1	6.7ms/dB	67ms/dB
ACF-2	0.1ms/dB	400ms/dB

Note: As the ACF Function limits the output signal under THD+N of 2-5% (but not 1%), there may still exist some audible distortion in the output signal. So, if high quality music is required without much distortion toleration, ACF should not be used.

(2) ACF OFF Mode

In ACF-Off mode, ACF function is disenabled. HT8699 will not detect output clipping and the system gain is kept to be $A_v=A_{v0}$. The audio quality would worsen due to clipping distortion.

(3) SD Mode

In shutdown mode, HT8699 shuts all circuit down and minimizes the power consumption. And, the output terminals become Weak Low (A high resistance grounded state).

● Pop-Click Noise Reduction

The Pop-Click Noise Reduction Function of HT8699 works in the cases of Power-on, Power-off, Shutdown on, and Shutdown off. To achieve a more excellent noise reduction performance, it is recommended to use a DC-cut capacitor (C_{IN}) of 0.1 μ F or less.

Besides, POP noise can be minimal according to the following procedure of shutdown control.

- During power-on, Shutdown mode is not cancelled until the power supply is stabilized enough.
- Before Power-off, set Shutdown mode first.

The pop-click noise: Power-on/-off > Shutdown on/off.

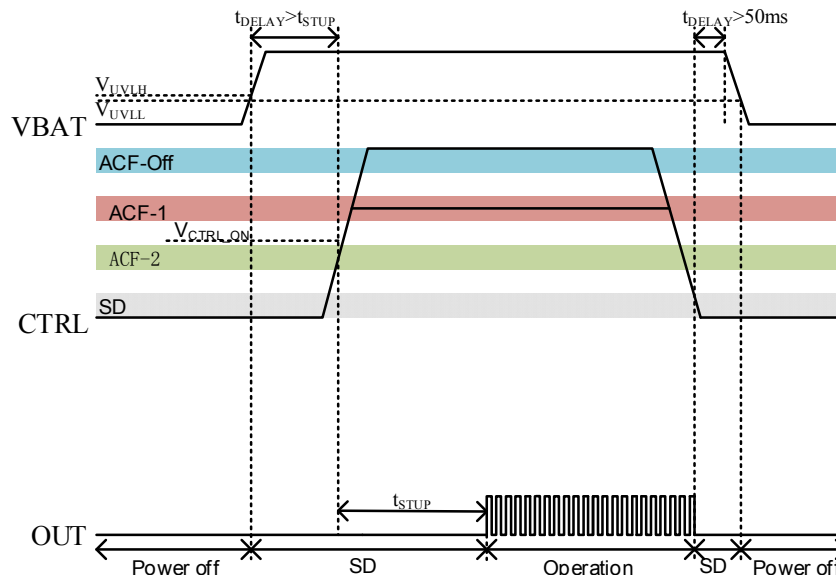

Fig. 6 Pop-Click Noise Reduction by Shutdown

● Protection Function

HT8699 has the protection functions such as Thermal Protection function, and Low Voltage Malfunction Prevention function.

(1) Over-current Protection function

When a short circuit occurs between one output terminal, the over-current protection mode starts up. In the over current protection mode, the differential output terminal becomes a high impedance state. Once the short circuit

conditions are eliminated, the over current protection mode can be cancelled automatically.

(2) Thermal Protection function

When excessive high temperature of HT8699 (150°C) is detected, the thermal protection mode starts up. In the thermal protection mode, the differential output terminal becomes Weak Low state (a state grounded through high impedance).

(3) Low voltage Malfunction Prevention function

This is the function to establish the low voltage protection mode when Vbat terminal voltage becomes lower than the detection voltage (V_{UVLL}) for the low voltage malfunction prevention. And the protection mode is canceled when Vbat terminal voltage becomes higher than the threshold voltage (V_{UVLH}). In the low voltage protection mode, the differential output pin becomes Weak Low state (a state grounded through high impedance). HT8699 will start up within the start-up time (T_{STUP}) when the low voltage protection mode is cancelled

PCB Layout

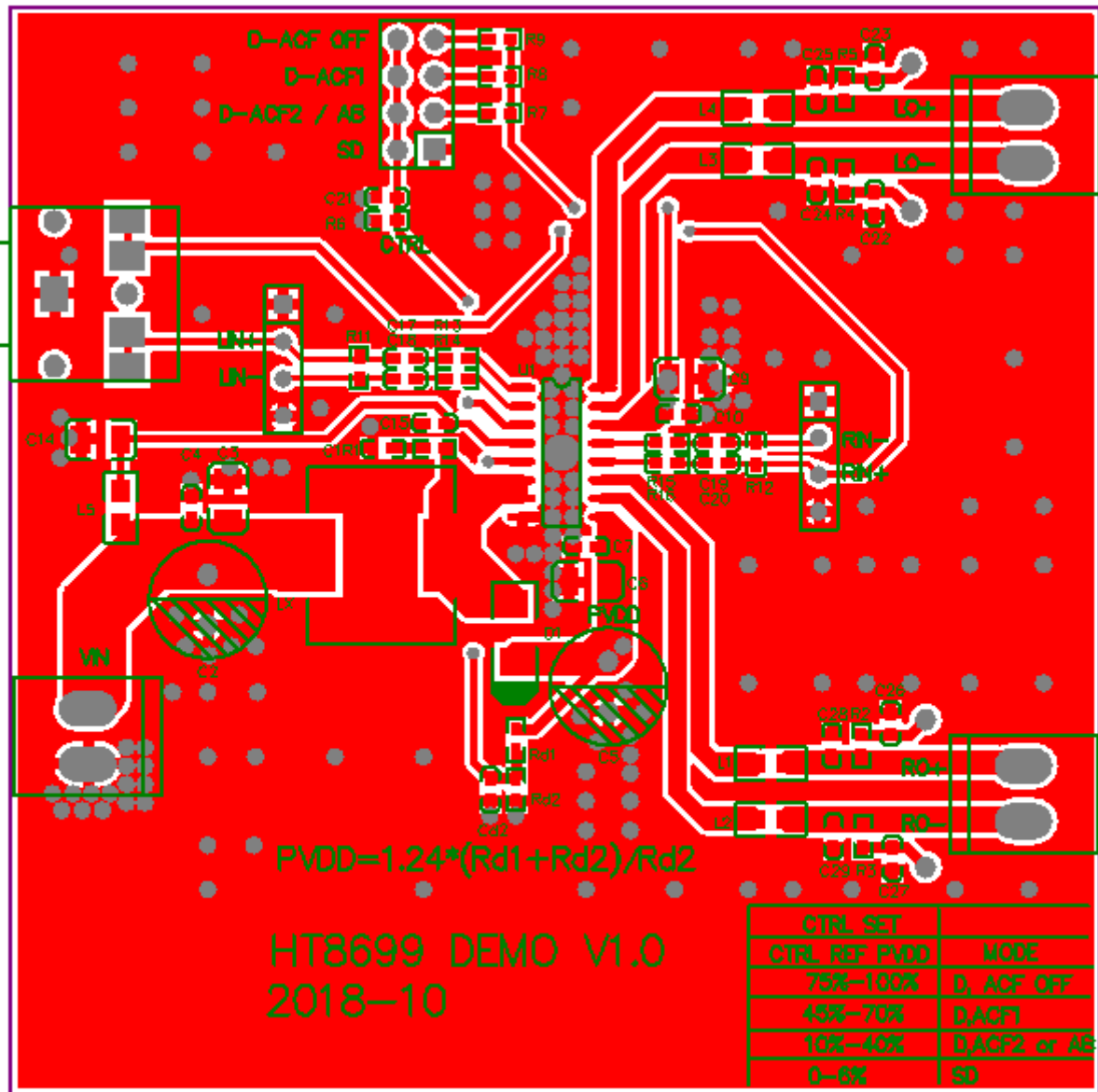

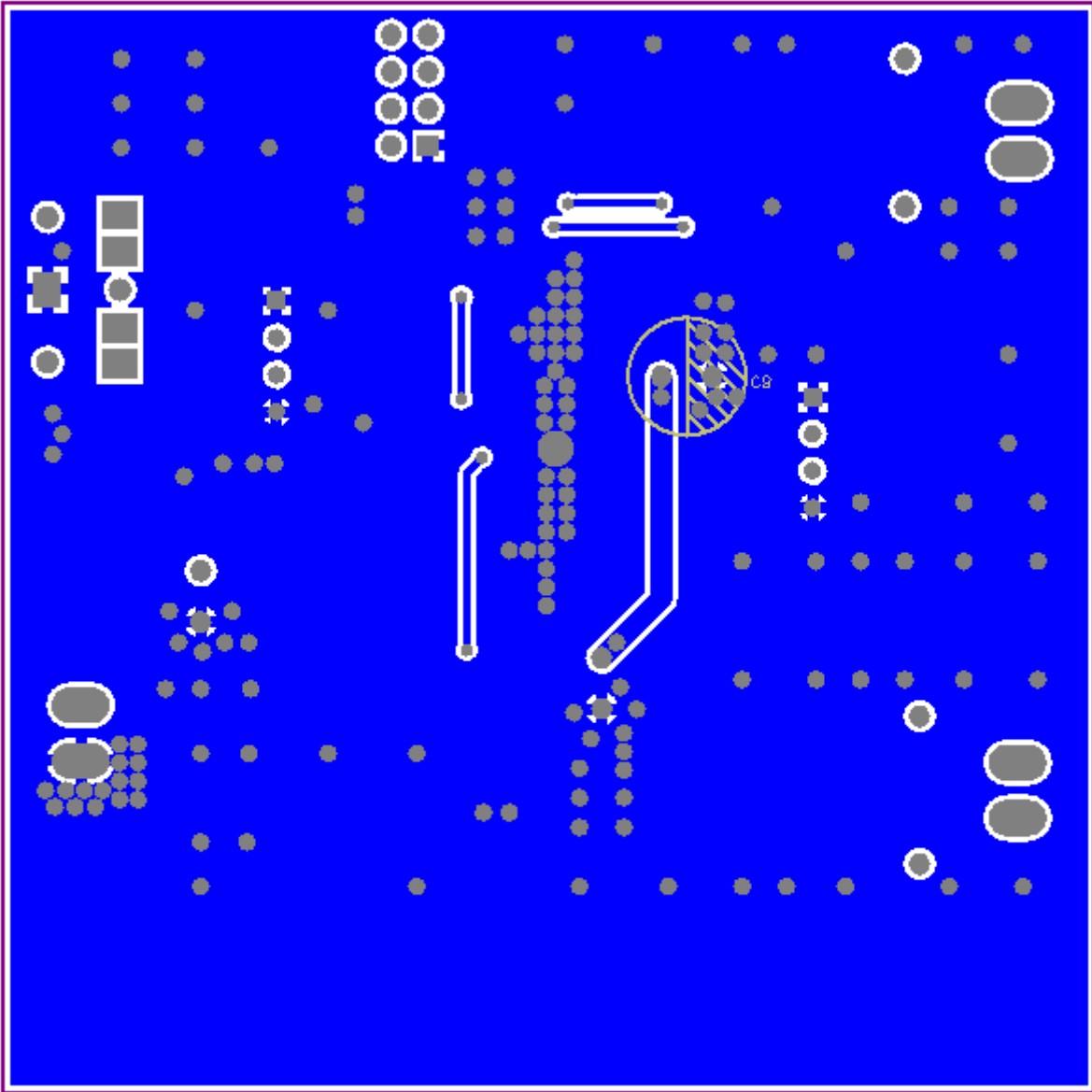

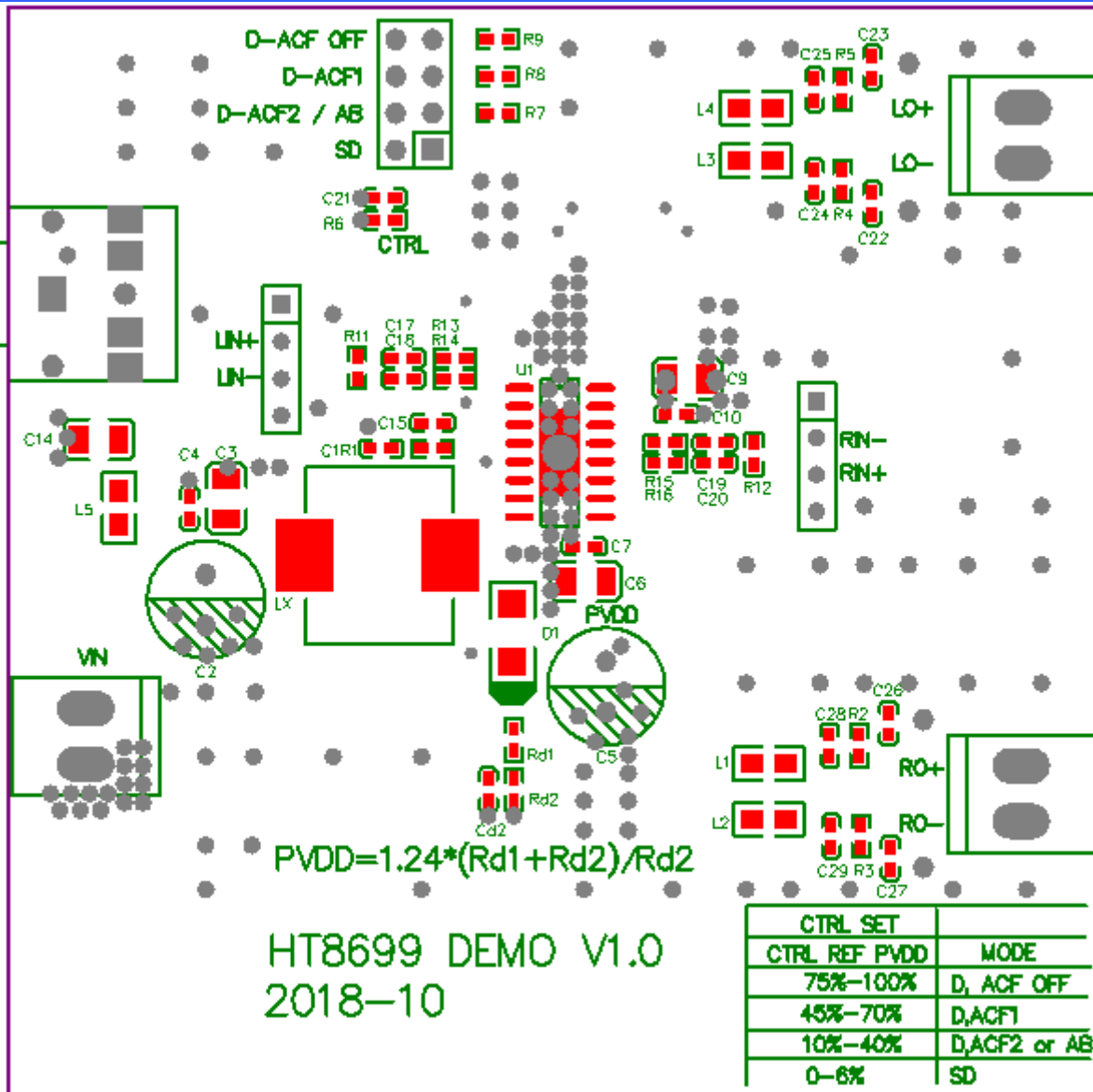

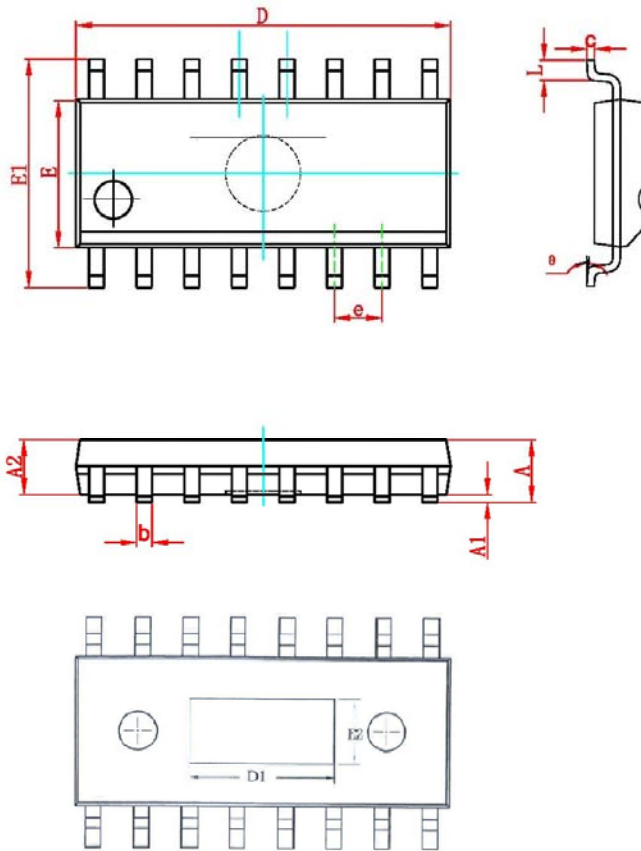
PACKAGE OUTLINE

Symbol	Dimensions (mm)	
	Min	Max
A	-	1.75
A1	0.05	0.15
A2	1.30	1.50
b	0.39	0.48
c	0.21	0.26
D	9.70	10.10
D1	4.57(REF)	
E	3.70	4.10
E1	5.80	6.20
E2	2.41(REF)	
e	1.27(BSC)	
L	0.50	0.80
θ	0°	8°

IMPORTANT NOTICE

注意

Jiaxing Heroic Electronic Technology Co., Ltd (HT) reserves the right to make corrections, modifications, enhancements, improvements, and other changes to its products and services at any time and to discontinue any products or services. Customers should obtain the latest relevant information before placing orders and should verify that such information is current and complete.

嘉兴禾润电子科技有限公司（以下简称HT）保留对产品、服务、文档的任何修改、更正、提高、改善和其他改变，或停止提供任何产品和服务的权利。客户在下单和生产前应确保所得到的信息是最新、最完整的。

HT assumes no liability for applications assistance or customer product design. Customers are responsible for their products and applications using HT components.

HT对相关应用的说明和协助以及客户产品的板级设计不承担任何责任。

HT products are not authorized for use in safety-critical applications (such as life support devices or systems) where a failure of the HT product would reasonably be expected to affect the safety or effectiveness of that devices or systems.

HT的产品并未授权用于诸如生命维持设备等安全性极高的应用中。

The information included herein is believed to be accurate and reliable. However, HT assumes no responsibility for its use; nor for any infringement of patents or other rights of third parties which may result from its use.

本文中的相关信息是精确和可靠的，但HT并不对其负责，也不对任何可能的专利和第三方权利的侵害负责。

Following are URLs and contacts where you can obtain information or supports on any HT products and application solutions:

下面是可以联系到我公司的相关链接和联系方式：

嘉兴禾润电子科技有限公司

Jiaxing Heroic Electronic Technology Co., Ltd.

地址：浙江省嘉兴市凌公塘路3339号JRC大厦A座三层

Add: A 3rd floor, JRC Building, No. 3339, LingGongTang Road, Jiaxing, Zhejiang Province

Sales: 0573-82585539, sales@heroic.com.cn

Support: 0573-82586151, support@heroic.com.cn

Fax: 0573-82585078

Website: www.heroic.com.cn; wap.heroic.com.cn

Wechat MP: HEROIC_JX

请及时关注禾润官方微信公众号，随时获取最新产品信息和技术资料！

